

DD36

FEATURES

Breathe cleaner air and enjoy less greasy residue in your kitchen

"Disappears" when not in use for a sleek, minimal look and use in open-concept kitchens

Lowers when not in use, and rises 14 inches to whisk away smoke and odors

Enjoy remote control operation within nine feet of unit

Matches the heavy-gauge stainless steel look of Sub-Zero, Wolf, and Cove

Select from internal, in-line, or remote blower options (blower required)

Automatically turns off the blower with a five-minute "delay-off" feature

Minimizes the backward flow of cold air with backdraft transition

Install a reversible motor box on either side of the downdraft for design flexibility

ACCESSORIES

10" Round Inline Damper

8" Round Inline Damper

Contemporary Cooktop/Downdraft Trim

Make-Up Air Damper

Recirculating Filter

Recirculating Kit

SRT Downdraft Trim

Inline Blowers

Internal Blowers

Remote Blowers

Accessories available through an authorized dealer.

For local dealer information, visit subzero-wolf.com/locator.



BLOWER OPTIONS

- 600 CFM Internal
- 600 CFM Inline
- 600 CFM Remote

PRODUCT SPECIFICATIONS

Model	DD36
Dimensions	36"W x 14"H x 2"D
Weight	80 lbs
Electrical Supply	110/120 VAC, 60 Hz
Electrical Service	15 amp dedicated circuit
Discharge Location	Vertical or Horizontal
Discharge Dimensions	6" round internal or 10" round inline or remote
Receptacle	3-prong grounding-type

ELECTRICAL

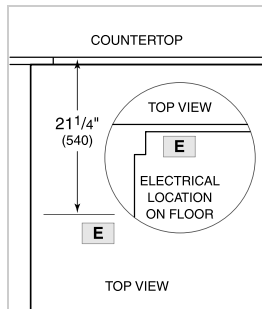

NOTE: Dimensions in parenthesis are in millimeters unless otherwise specified

DIMENSIONS

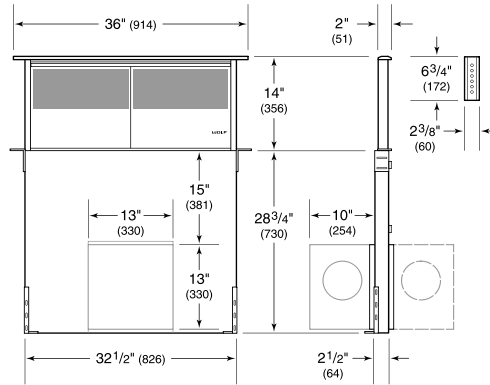

NOTE: Shown with front mounted internal blower with 6" (152) round discharge, dashed line represents rear mount.

STANDARD INSTALLATION

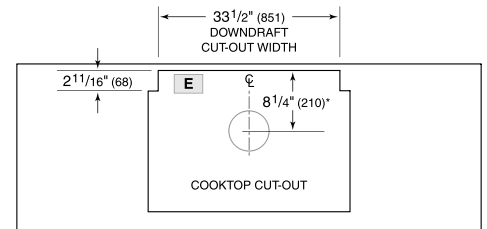

TOP VIEW

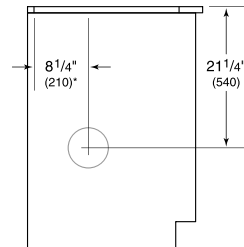

SIDE VIEW

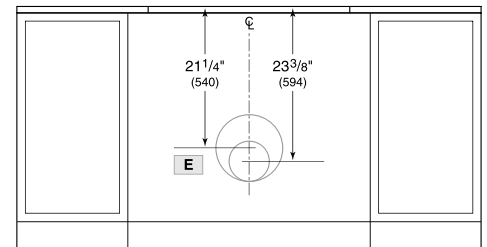

FRONT VIEW

*6" (152) back from countertop cut-out when internal blower is rear mounted.

NOTE: Internal blower 6" (152) round, side, rear or bottom discharge. In-line and remote blower 10" (254) round, rear discharge. Centerline indicates center of downdraft cut-out.